

**NORTH CAROLINA RAILROAD COMPANY**

**SPECIFICATIONS  
FOR  
WIRE, CONDUIT AND CABLE OCCUPATIONS OF  
NORTH CAROLINA RAILROAD COMPANY PROPERTY**

**FORM NCR 101**



**Revised  
January 2024**

INDEX

<u>Section</u>	<u>Title</u>	<u>Page No.</u>
1.0	General.....	3
1.1	Scope.....	3
1.2	Definitions .....	3
1.3	Application for Occupancy .....	3
1.4	Right of Entry .....	4
1.5	Site Inspection.....	4
1.6	Information Required for Submission .....	4
1.7	Notification to Proceed with Construction.....	6
1.8	Crossing in the vicinity of Railroad bridges and Other Structures .....	7
1.9	Overhead Bridge Structures for Wires and Cables .....	7
2.0	General Requirements.....	8
2.1	General.....	8
2.2	Above Ground and Aerial Wirelines .....	8
2.3	Underground Installations.....	9
2.4	Longitudinal Occupancies .....	11
2.5	Inductive Interference .....	11
2.6	Inspection.....	12
2.7	Maintenance.....	12

APPENDIX

	<u>Title</u>	<u>Page No.</u>
Plate I	Plan of Drawings when Facility is a Crossing .....	13
Plate II	Cross Section of Drawings when Facility is a Crossing .....	14
Plate III	Plan View of Drawings When Facility is a Longitudinal Occupation .....	15
Plate IV	Profile Section of Drawings When Facility is a Longitudinal Occupation .....	16
Plate V	Minimum Requirements for Underclearance of Wires of Various Voltages .....	17
Plate VI	Example Plan View for Aerial Wireline .....	19
Plate VII	Example Profile View for Aerial Wireline.....	20
Plate VIII	Example Plan View for Underground Wireline .....	21
Plate IX	Example Profile View for Underground Wireline .....	22

## 1.0 General

### 1.1 Scope

- A. This specification shall apply to the design and construction of wire, conduits and cables which are to be located over, under, across and along North Carolina Railroad Company (NCRR) corridor or property and facilities. This specification shall also apply to tracks owned by others (sidings, industry tracks, etc.) which are connected to NCRR and used by the Operating Railroad.
- B. It is to be clearly understood that NCRR owns its Corridor for the primary purpose of railroad operations. All occupancies shall therefore be designed and constructed so that operations and facilities are not interfered with, interrupted or endangered. In addition, the proposed facility shall be located to minimize encumbrance to the Corridor so that railroad will have unrestricted use of its property for current and future operations.

### 1.2 Definitions

- A. NCRR North Carolina Railroad Company
- B. Operating Railroad A railroad company designated by NCRR to operate trains on its corridor. Currently, Norfolk Southern Corporation (NS), and in some places CSX Transportation (CSXT).
- C. Engineering Representative Person or persons designated by NCRR to review and approve plans for pipeline occupancies of its corridor. Currently HNTB North Carolina, P.C.
- D. Owner (Applicant) Individual, corporation, municipality desiring occupancy of the NCRR Corridor.
- E. Professional Engineer Engineer licensed in North Carolina
- F. Casing Pipe Pipe through which the carrier pipe is installed.
- G. Carrier Pipe Pipe through which wirelines are installed.
- H. Sidings or industry tracks Tracks located off NCRR's Corridor, serving an industry.

### 1.3 Application for Occupancy

- A. Corporations or municipalities desiring occupancy of the NCRR Corridor by utility occupations must agree, upon approval of the engineering and construction details by the Engineering Representative, to execute an appropriate NCRR utility occupancy agreement and pay any required fees and/or rentals specified therein. Applications will be accepted from the Owner or his designated representative, herein after referred to as the Applicant.
- B. The application process and guidelines for a wireline occupancy can be found at <https://www.ncrr.com/corridor-access/best-practices-for-utilities/>, then follow links to the Pipeline and Underground/Aerial Wireline Occupancy (NCRR 230).pdf
- C. All applications shall be submitted through the web-based NCRR application portal at <https://engineering.ncrr.com/> and require a .pdf copy of all design and construction plans, specifications, and engineering computations. On extensive projects, only those plans involving work on, or affect NCRR property, shall be submitted. Included shall be a plan showing the extent of the total project upon which that portion of the work affecting NCRR is clearly defined.

- D. All of the above plans, specifications, and computations must be prepared by and bear the seal of a Professional Engineer registered in the State of North Carolina.

#### **1.4 Right of Entry**

- A. No entry upon NCRR property for the purpose of conducting surveys, field inspections, obtaining soils information or any other purposes associated with the design and construction for the proposed occupancy, will be permitted without a proper right of entry permit prepared and issued by the North Carolina Railroad Company. The applicant must complete and submit to the NCRR Infrastructure Manager the right of entry application, required insurances, associated fees, if any, and then execute the right of entry permit.
- B. It is to be clearly understood that the issuance of a right of entry permit does not constitute authority to proceed with any construction. Construction cannot begin until a formal utility occupancy agreement is executed by NCRR, the Operating Railroad, and Owner; and the Owner then receives permission from the Engineering Representative to proceed with the work.

#### **1.5 Site Inspection**

- A. Site inspection may be required for all new installations, construction activities, removal and/or modifications to existing facilities.
- B. For longitudinal occupancy of the NCRR Corridor, a site inspection along the proposed wire, cable, or conduit route may be required before final design plans are approved. When a site inspection is required, the applicant and/or his engineer must meet with the Engineering Representative to view the entire length of the proposed occupancy.
- C. Prior to the site inspection the applicant must submit the following information:
1. A plan view of the proposed route showing all tracks, both NCRR Corridor lines and all other facilities located on the Corridor. The distance from the proposed wire, cable or conduit to both the adjacent track and the Corridor lines must be shown.
  2. A completed application form and associated fees.
  3. Typical cross sections along the proposed route.
- D. Site inspections for wire, cable, or conduit crossings are not required unless, in the opinion of the Engineering Representative, the size and location of the facility warrant an inspection.

#### **1.6 Information Required for Submission**

##### **1.6.1 Plans and Computations**

- A. Plans for proposed utility occupancies shall be submitted on the NCRR Engineering Portal and must be approved prior to NCRR issuing a Utility Occupancy Agreement and the start of construction.
- B. Plans shall be drawn and printed to scale and shall include the following information as a minimum. (See Plates I to IX)
1. Plan view of crossing or longitudinal wireline occupation in relation to all NCRR facilities and facilities immediately adjacent to NCRR including, but not limited to, tracks, buildings, signals, pole lines, other utilities and all other facilities that may affect or influence the wireline design and construction. (Plate I)

2. The location, in feet, of the crossing from the lowest nearest Mile Post (NCRR only accepts positive mileposts (Ex. MP 320 + 1000')) and/or centerline of a NCRR bridge, giving the bridge number. (See Plate VIII)
3. If applicable, AAR/DOT number of grade crossings should be indicated on the plans. The number is on a metal tag located on the cross buck or flasher post in the format 123 456B. (See Plate VI)
4. The name of the City/Town and County in which the proposed facilities are to be located. (Plate VI)
5. The profile of the utility along the centerline of pole or tower line, showing actual vertical clearances over the high rail, between top of the high rail and bottom of sag, and clearances from bottom wire or cable to top wire or cable of railroad's transmission, signal and communication lines. If multiple overhead lines exist or are being proposed, top of high rail to bottom of sag dimensions are required for each wire. If railroad facilities listed above do not exist at the point of crossing, the plan should so state. (Plate IV) (See Plate V for the required overhead clearance.)
6. A fully dimensioned Cross Section of the proposed wireline shall be drawn perpendicular to the track. (Plate VII)
7. Show and label all known property lines and the NCRR Corridor lines. Show dimensions from the centerline of the corridor and track(s) to the Corridor line and the overall width of the NCRR Corridor. If wires, cables or conduits are within 100 feet of roadway crossings, show the distance from the edge of pavement to the centerline of proposed poles. (Plate I)
8. The angle of the crossing in relation to the centerline of the track(s). (See Plate I)
9. The plan must be specific, as to:
  - a. Base diameter, height, class and bury of poles. Poles shall be set as close to the NCRR Corridor line as possible with every effort being made to locate poles off the NCRR Corridor and in no instance closer than 28'-0" from face of pole to centerline of nearest track. When necessary, however, each location will be analyzed to consider train speeds, railroad traffic, etc.
  - b. Number of, size and material of power wires and nominal voltage of line, or number of pairs or fibers in communication cables.
  - c. Location, number of, size of, and material of anchors and all guying for poles and arms.
  - d. All guying for poles shall be labeled as proposed or existing.
10. The following shall be specified for underground crossings:
  - a. Size and character of conduit and casing pipe.
  - b. Depth below base of rail.
  - c. Number of conduits and/or innerducts.
  - d. Depth on Corridor at lowest amount of cover, under ditches, and at the Corridor line.
  - e. Theoretical Railroad Embankment Line (See NCR 102 Section 4.3.1.G)

11. The following note shall be included on all plan and profile sheets:

*All work on the NCR Corridor to be performed in accordance with North Carolina Railroad Specifications NCR 101 "Specifications for Wire, Conduit and Cable Occupations of North Carolina Railroad Company Property", NCR 102 "Specifications for Pipeline Occupancy of North Carolina Railroad Property" and "North Carolina Railroad / Norfolk Southern Railway– Special Provisions for Protection of Railway Interest (Current version)".*

If the occupancy application is for an aerial wireline occupancy only, reference to NCR 102 can be omitted.

12. For underground occupancies, a cross section of the utility occupancy shall be included on the plan view drawing. The cross section shall show the conduit, number of innerducts and, wires contained within each innerduct and if any innerducts are empty. All underground crossings shall also meet the requirements of Form NCR 102 "Specifications for Pipeline Occupancy".

- C. For all installations on NCRR property and over tracks that are not owned by NCRR but are used by the operating railroad (i.e. private industry tracks), the plans shall be prepared to the same requirements as if the tracks were owned by NCRR.
- D. These items cannot have an alternative and any application that is received that indicates options in any of the above items will not be processed.
- E. Once the application has been approved by the Engineering Representative, no variance from the approved plans, specifications, method of installation, construction, etc., will be considered or permitted without the payment to the Engineering Representative of additional fees for the re-processing and review of the application. Revisions to the approved plans may also impact the utility occupancy license fee.
- F. All plans and computations associated with the work under the agreement shall be prepared by, and bear the seal of, a Professional Engineer registered in the State of North Carolina. If not so imprinted, the application will be given no further consideration. This requirement also applies to all data submitted by the Owner's contractor. Contractor's plans and computations that are not stamped, signed and dated will be returned and construction will not be permitted to proceed.
- G. All plans and computations associated with the work under the agreement shall include the company name, address, and North Carolina Board of Examiners for Engineers & Surveyors license number on each sheet of engineering drawings.

### 1.6.2 Specifications

- A. Project specifications for all work on and affecting the railroad corridor, shall be included with the submission. All pertinent requirements of this document shall be included.

### 1.7 Notification to Proceed with Construction

- A. After approval of the engineering plans and specifications and execution of the Occupancy Agreement, the Owner will submit a request to the Operating Railroad online portal prior to the start of construction. The Operating Railroad will provide inspection of the project and coordinate all other construction aspects of the project that relate to railroad operations (flagging, track work, protection of signal cables, etc.).

- B. The scheduling of work is subject to the availability of Operating Railroad force account support. The Owner shall coordinate with the Operating Railroad for scheduling of work on the NCRR Corridor. No work shall be performed without the approval of the Operating Railroad. Typically, the Operating Railroad must be notified a minimum of ten (10) business days prior to desired start of construction.

### 1.8 Crossing in the vicinity of Railroad bridges and Other Structures

- A. Wires, conduits, and cables shall: be located as far from bridges and others structures as practicable, cross tracks at close to perpendicular as possible (but not less than 45 degrees), not be placed within a culvert, and not be closer than 50 feet to any portion of any railway bridge, building, or other important structure, except in special cases and then by special design as approved by NCRR (NCR 102 Plate VI).

### 1.9 Overhead Bridge Structures for Wires and Cables

- A. New overhead structures shall not be constructed on NCRR's Corridor unless underground installation is not possible and/or the Applicant can show that no practicable alternative is available
- B. When forwarding requests of this nature, utilize the Application for Wire, Conduit and Cables to the fullest extent possible. Along with the standard project drawings, complete structural plans and design computations for the structure and foundations, sealed by a Professional Engineer registered in the State of North Carolina, are also required.
- C. The **desired minimum** vertical clearance for new bridges and structures over main tracks, measured at a distance of 5'-6" from centerline of track shall be 24'-3" at the following locations in order to provide for the potential of future electrification by means of an overhead catenary system (designated route for the Southeast High Speed Rail Corridor).
- NCRR NC-Line, Greensboro to Raleigh (MP 000.00-NC to MP H 080.70-NC)
  - NCRR Main Line, Charlotte to Greensboro (MP 284.0 to MP 378.3)
- D. The **absolute minimum** vertical clearance at these locations shall be 23'-0".
- E. The **absolute minimum** vertical clearance for new bridges and structures over main tracks, measured at a distance of 5'-6" from centerline of track shall be 23'-0" at the following locations:
- NCRR NC-Line, Raleigh to Goldsboro (MP 080.70-NC to MP 130.00-NC).
  - NCRR EC-Line, Goldsboro to near Kinston (MP EC-0.0 to MP EC-22.3).
- F. The **absolute minimum** vertical clearance for new bridges and structures over main tracks, measured at a distance of 5'-6" from centerline of track, at the following locations shall be 24'-11":
- NCRR EC-Line, near Kinston to Morehead City (MP EC-22.3 to MP EC-94.2).

## 2.0 General Requirements

**Note: At the following locations, the NCRR Corridor is shared with CSXT. Refer to CSXT utility specifications for additional requirements prior to application submittal. Pipe and wire occupancies within these limits are required to obtain proof of engineering approval from CSXT in addition to NCRR/NSR.**

- **Between downtown Cary, MP 073.00-NC, and downtown Raleigh, MP 080.00-NC (CSXT MP S-164.4 to MP S-157.4)**
- **In downtown Durham between, MP 056.00-NC and MP 057.00-NC**

### 2.1 General

- A. All construction is subject to the requirements of the current version of the document titled "North Carolina Railroad / Norfolk Southern Railway – Special Provisions for Protection of Railway Interests".
- B. Overhead power and communication lines shall be constructed in accordance with the National Electrical Safety Code (current edition), Part 2, "Safety Rules for the Installation and Maintenance of Overhead Electric Supply and Communication Lines", except where more conservative requirements are noted herein.
- C. Under special conditions, NCRR will give consideration to occupations on its structures, subject to approval of the NCRR, the Operating Railroad, and NCRR's policy governing such matters.
- D. Wirelines shall be located, where practicable, to cross tracks at approximately right angles to the track but preferably not less than at a 45-degree angle to the centerline of track.
- E. All operations shall be conducted so as not to interfere with, interrupt, or endanger the operation of trains; nor damage, destroy or endanger the integrity of railroad facilities. All work on or near the NCRR Corridor shall be conducted in accordance with the safety rules and regulations of the Operating Railroads.

### 2.2 Above Ground and Aerial Wirelines

- A. The poles, or towers, supporting the crossing span shall, preferably, be outside the NCRR Corridor. If locating the poles or towers outside the Corridor is not possible, the side clearance of poles, towers, and guy wires from the nearest track rail shall be not less than 28 feet.
- B. Wires and cables running longitudinally along NCRR's Corridor shall be constructed as close to the Corridor lines as possible, except in cases where doing so will interfere with Railroad operations, surface drainage, or soil stability.
- C. The poles, or towers, supporting the crossing span and the adjoining span on each side shall, preferably, be in a straight line.
- D. Crossing poles and towers shall be located as far as practicable from flammable structures. The space around the poles and towers shall be kept free from underbrush, grass, and other flammable material.



- E. For the protection of the aerial wire crossing and railroad pile driver operation, it is preferable that aerial wire crossings be located 1,000 feet or more from any railroad bridge, trestle or large culvert. Where necessary to locate the crossing less than 1,000 feet from such bridge, trestle or large culvert, the vertical clearance of the wire shall be not less than 50 feet above top of rail.
- F. The poles or structures supporting the crossing span shall be plainly marked with the name, initials or trademark, and the pole numbers, if used, of the utility owner. When required by NCRR, the utility owner shall place on all crossing structures located on the property of NCRR, warning signs of approved design.
- G. Guys shall be placed in such a manner as to keep the pole from leaning or falling in the direction of the tracks.
- H. All parts of the supporting structures of the crossing span shall be examined annually by the owner and all defective parts shall be promptly restored to a safe condition.
- I. The minimum horizontal and vertical clearances of wires to the railroad are as indicated on Plate V of these Specifications. Guy wires and suspension cable systems may be located no closer than 27 feet above top of rail. Messenger cable with communications cables or fiber optic cables are subject to the vertical clearances on Plate V.
- J. Double cross-arms are required on poles adjacent to track. Any tower or steel pole foundation design must be accompanied by engineering computations and date stamped by a registered professional engineer. Any tower or steel pole to be installed on the NCRR Corridor must meet or exceed industry standards regarding design and usage.
- K. All work shall be done without interfering with the Operating Railroad's signal systems and cables.

### **2.3 Underground Installations**

- A. All underground installations carrying power or communication wires and cables shall be constructed and properly marked with signs, in accordance with "Specifications for Pipeline Occupancy of NCRR Property", Specification NCR 102, current edition.
- B. In addition to the requirements of these specifications, the underground installations are required to conform to the requirements of the National Electrical Safety Code, as published by the National Standards Institute, Inc. the current edition of same being controlling. The underground installations also to conform to the requirements of any local or state laws or regulations of any local code enforcing authority that may be in effect at the time of the installation.
- C. The cable or duct system of proposed underground crossings shall be laid as straight and direct as possible between the points where the underground line enters and leaves the NCRR Corridor.
- D. Conduits shall not be located within 50 feet of the limits of a turnout (switch) when crossing the track. The limits of the turnout extend from the point of the switch to the last long timber.
- E. Conduits shall not be located within 50 feet of a control point area. The limits of the control point area are governed by the signal system regulating the control point.
- F. Where possible, bore pits, manholes, handholes, pull boxes, and terminals in underground crossings should be located off the NCRR Corridor.

- G. The tops of ducts and cable systems structures of underground crossings shall be located at a depth of not less than 66 inches below base of rail and not less than 48 inches below ground level for all other points on NCRR property.
- H. Cable marker signs for underground crossings must be installed on both sides of the track at points of Corridor entry and exit and 15ft from the center of outside tracks, over the centerline of the pipe (except those in streets where it would not be practicable to do so). Signs shall show the following:
1. Name and address of owner
  2. Contents of pipe
  3. Voltage of conduit
  4. Pipe depth below grade at point of a sign
  5. Emergency telephone number
- I. For underground installations running longitudinally on the NCRR Corridor, signs shall be placed over the underground installation (or offset and appropriately marked) at all changes in direction of the installation. Such signs should also be located so that when standing at one sign the next adjacent marker in either direction is visible. In no event shall they be placed more than 500 feet apart unless otherwise specified by the Engineering Representative.
- J. Plastic conduit material includes thermoplastic and thermoset plastic conduits, such as PVC and HDPE.
- K. Underground crossings of power supply cables with maximum voltage of 750 volts and communication cables of low voltage or fiber optic cables may be installed by pushing a galvanized steel pipe under the tracks to serve as a conduit. Such pipe installed at the depths specified above and shall extend the entire length of the crossing within NCRR's corridor. (This distance may be decrease at the discretion of the Railroad).
1. All ducts and/or encasements beneath the tracks must be capable of withstanding Cooper E-80 loading and conform to AREMA Guidelines.
  2. Any conduits and/or encasements larger than four inches will be governed entirely by those specifications which normally cover pipelines – "Specifications for Pipeline Occupancy of NCRR Property", Specification NCR 102 current edition.
  3. Jacking or boring installation is preferred, and no water is to be used in the installation of the encasement
- L. Underground crossings of power supply cables operating above 750 volts will be installed at depths specified above and shall be entirely encased when within the NCRR Corridor in galvanized steel pipe or approved concrete encased duct for mechanical protection of the cable. No cable of this potential which is unprotected will be permitted on the NCRR Corridor.
1. It is not allowed within 50 feet from the centerline of existing or future tracks, as approved by the Engineering Representative.
  2. It shall be encased in a minimum of 12 inches of concrete to the outer face of the conduit across the entire width of the NCRR Corridor.

## 2.4 Longitudinal Occupancies

- A. Longitudinal occupancies shall only be constructed within the NCRR Corridor where there is no other practicable alternative.
- B. If a request is made for longitudinal occupancies of the NCRR Corridor, the following must accompany the application and related project drawings:
  - 1. An overall plan view of the proposed route, showing all tracks and the NCRR Corridor lines. The distance from the proposed occupancy to the adjacent track(s) and to the Corridor lines must be shown.
  - 2. A written project outline that includes the general scope of the project, as well as justification for the longitudinal request and an explanation why there are no other practicable alternative routes.
- C. Wire, conduit and cable lines laid longitudinally on NCRR's Corridor shall be located as far as possible from tracks and any other important structures and as close to the NCRR Corridor line as possible as it is understood that NCRR maintains its Corridor for the primary purpose of operating a railroad. All occupancies shall therefore be designated and constructed so that railroad operations and facilities are not interfered with, interrupted or endangered. In addition, the proposed facility shall be located to minimize encumbrance to the Corridor so that the railroad will have unrestricted use of its property for current and future operations. No new occupancies will be allowed within 25 feet of the centerline of track.
- D. Wires and cables running longitudinally along the NCRR Corridor shall be constructed as close to the NCRR Corridor lines as possible. The following information must be submitted in addition to the information called for on Plates III and IV of these specifications:
  - 1. Voltage of circuit(s) or number of pairs/fibers.
  - 2. Phase of electrical circuit(s).
  - 3. Number of electrical circuits.
  - 4. Size (AWG or CM) and material of wires or cables.
  - 5. Length of spans clearly indicated on drawing.
  - 6. Any intended future wires or cables.
- E. Any facilities overhanging the NCRR corridor must have approval of the NCRR Engineering Representative and the Operating Railroad, must conform to the above specifications, and are subject to the appropriate occupancy fees.

## 2.5 Inductive Interference

- A. An inductive interference coordination study is required for all proposed electrical power longitudinal occupations. This study may also be required for any crossing other than 90° with the track(s).
- B. All agreements covering crossings and longitudinal occupations, will include provisions that the owner provide appropriate remedies, at his own expense, to correct any inductive interference with NCRR's or the Operating Railroad's facilities.

## **2.6 Inspection**

- A. The construction shall be subject to the inspection of NCRR and shall comply with the requirements of these specifications. Defective material shall be rejected and replaced with acceptable material.
- B. Crossings that are not installed in conformance with the plans and specifications submitted with the Application are subject to modification or removal, as determined by NCRR and/or the Operating Railroad, at the Applicant's expense.

## **2.7 Maintenance**

- A. The crossing shall be maintained in safe condition. The poles, cross arms, insulators, guys, wires, and other parts and materials used in the structure of the crossing shall be periodically inspected, and all defects shall be promptly repaired by the owner of the line. The guys and anchors shall be maintained so that the guys are kept taut and serve the purpose for which they are intended. The line wires shall be kept to the proper sag. Underbrush, grass, or other flammable material shall be kept removed by the crossing owner from the poles for a sufficient distance to reduce the fire hazard to the minimum.

# PLATE I

INFORMATION TO BE SHOWN ON PLAN OF DRAWINGS  
WHEN FACILITY IS A CROSSING

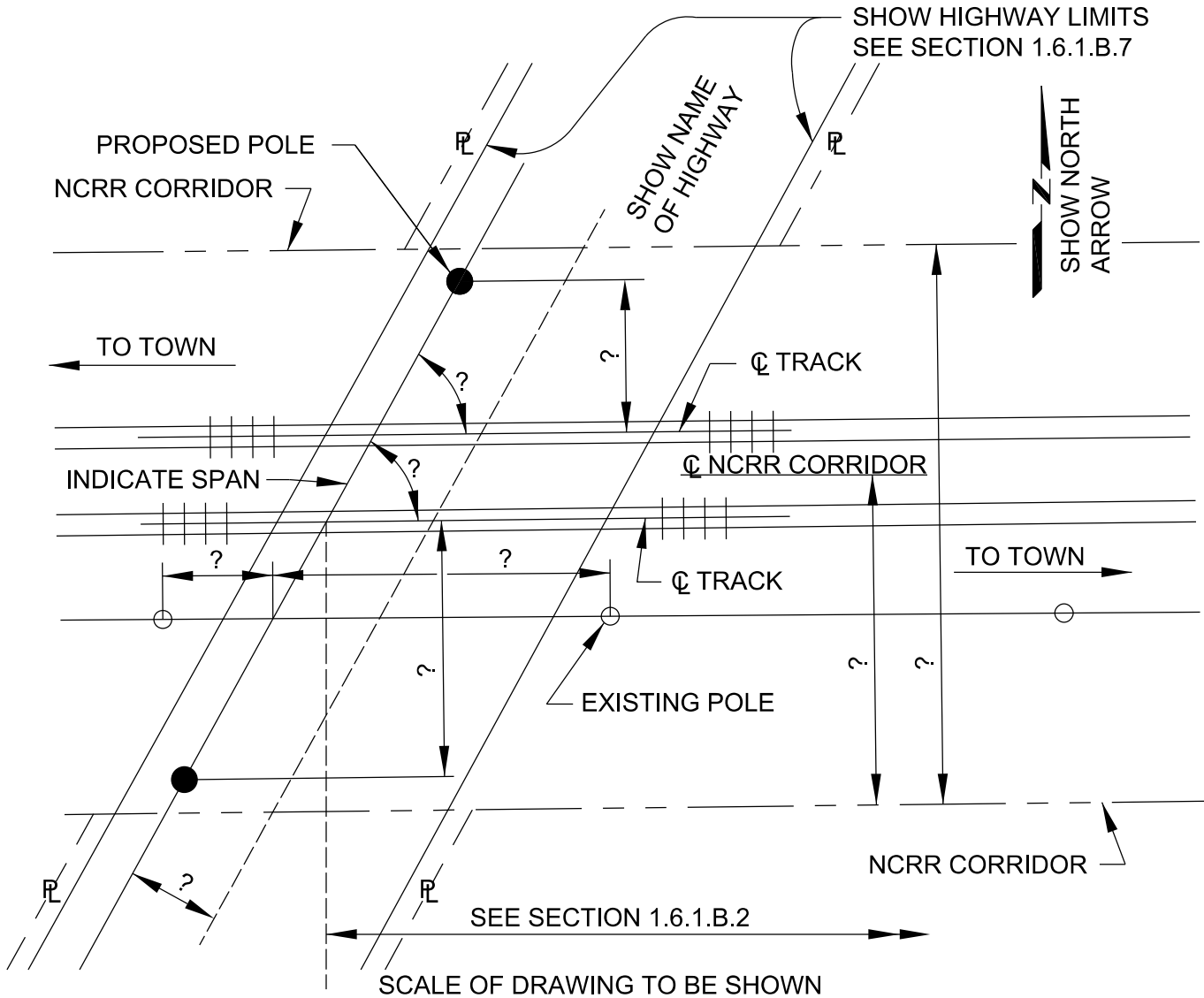

**NOTES:**

IF THE PROPOSED LINE IS TO SERVE A NEW DEVELOPMENT, A MAP SHOWING THE AREA IN RELATION TO ESTABLISHED AREAS AND ROADS IS TO BE SENT WITH THE REQUEST.

IF THE PROPOSED LINE IS NOT WHOLLY (OR PARTIALLY) WITHIN HIGHWAY LIMITS, THE SAME INFORMATION IS REQUIRED AS SHOWN ON THIS PLATE.

LOCATE NCRR C&S FACILITIES AT CROSSING, IE, CANTILEVERS, FLASHERS, GATES AND SHOW CLEARANCES FROM EACH FACILITY.

POLES SHALL BE LOCATED AS CLOSE TO THE NCRR CORRIDOR LINE AS POSSIBLE.

# PLATE II

INFORMATION TO BE SHOWN ON CROSS SECTION OF DRAWINGS  
WHEN FACILITY IS A CROSSING

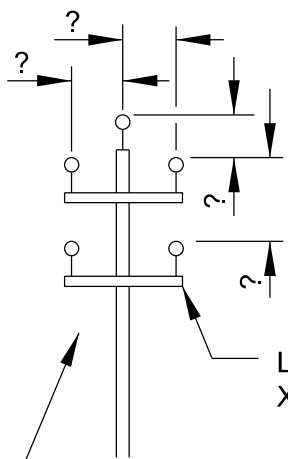
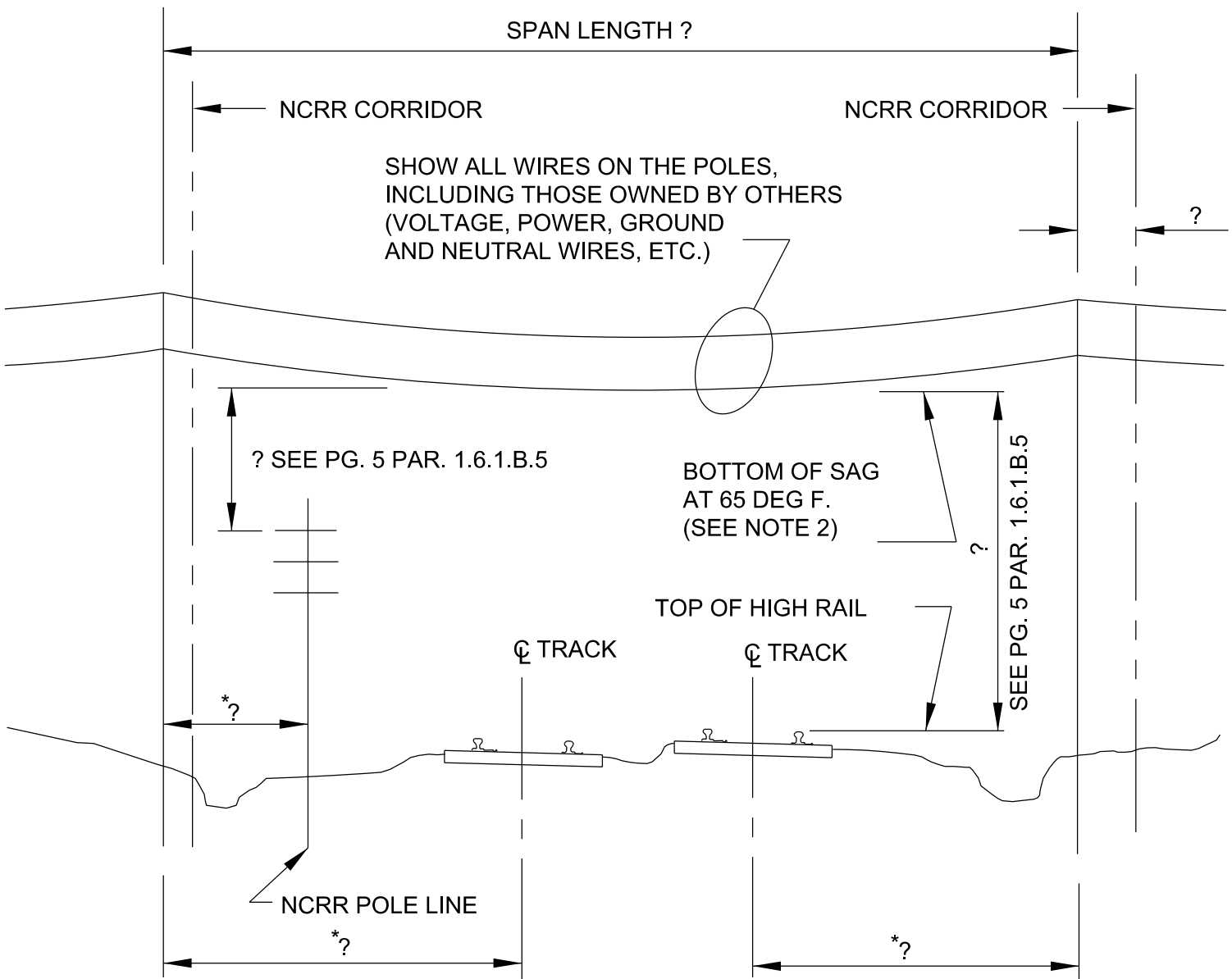

POLE TOP  
CONFIGURATION  
TO BE SHOWN

SECTION LOOKING (DIRECTION)  
SCALE: H \_\_\_\_\_  
V \_\_\_\_\_

\* MEASURED AT RIGHT ANGLES TO TRACK

- NOTE 1: ALL TRANSMISSION, SIGNAL, AND COMMUNICATION LINES SHOULD BE INDICATED AND PROPER CLEARANCES SHOWN.
- NOTE 2: SHOW MAXIMUM SAG INCREASE OF POWER WIRES OVER TRACKS IF SPAN EXCEEDS 175 FEET IN LENGTH.

# PLATE III

INFORMATION TO BE SHOWN ON PLAN VIEW OF DRAWINGS  
WHEN FACILITY IS A LONGITUDINAL OCCUPATION  
SCALE OF DRAWING TO BE SHOWN

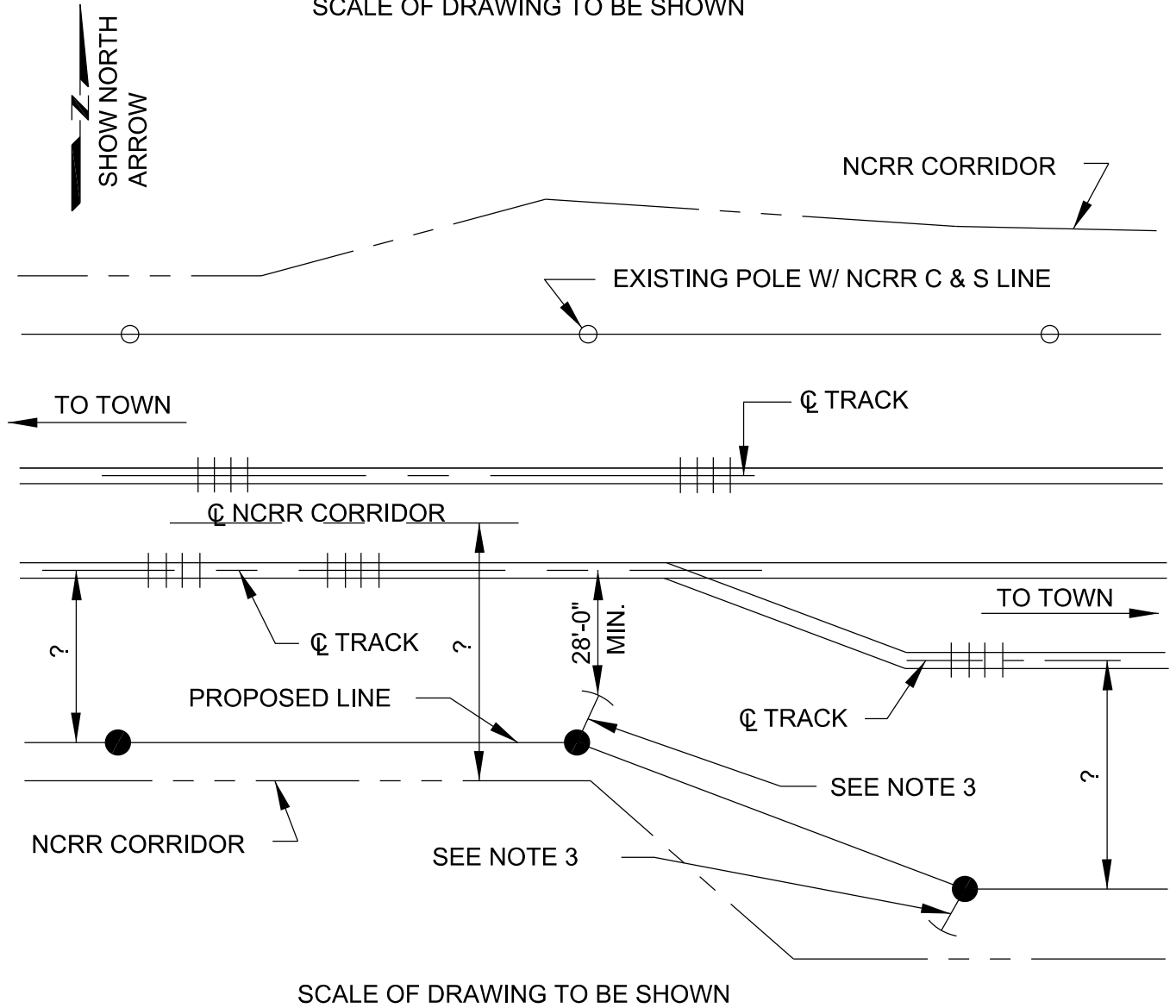

**NOTES:**

1. EACH END OF THE LINE MUST SHOW MEASUREMENTS AS CALLED FOR ON SECTION 1.6.1.B.2.
2. IF POWER LINE CROSSES ANY TRACK, THEN THE INFORMATION SHOWN ON PLATE I IS ALSO REQUIRED.
3. WHERE ANCHOR GUYS ARE REQUIRED, THE MINIMUM CLEARANCE MUST BE 28'-0" FROM FACE OF ANCHOR TO CENTERLINE OF NEAREST TRACK. CROSS SECTIONS MUST BE SUBMITTED FOR ALL ANCHOR LOCATIONS.
4. THE DISTANCE BETWEEN EACH POLE IS TO BE SHOWN.
5. ASSIGNED POLE NUMBERS TO BE SHOWN AT EACH POLE.

# PLATE IV

INFORMATION TO BE SHOWN ON PROFILE SECTION OF DRAWINGS  
WHEN FACILITY IS A LONGITUDINAL OCCUPATION

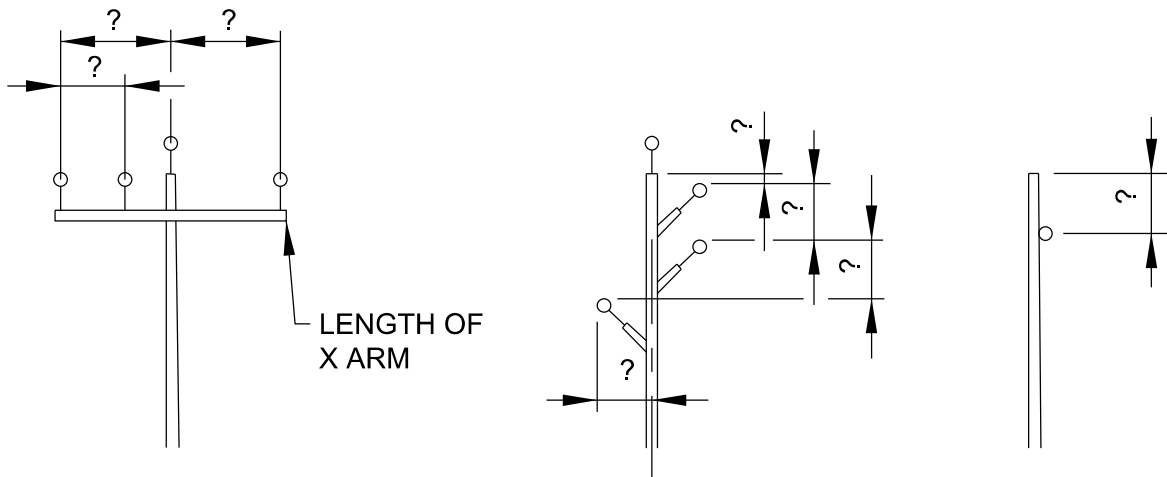
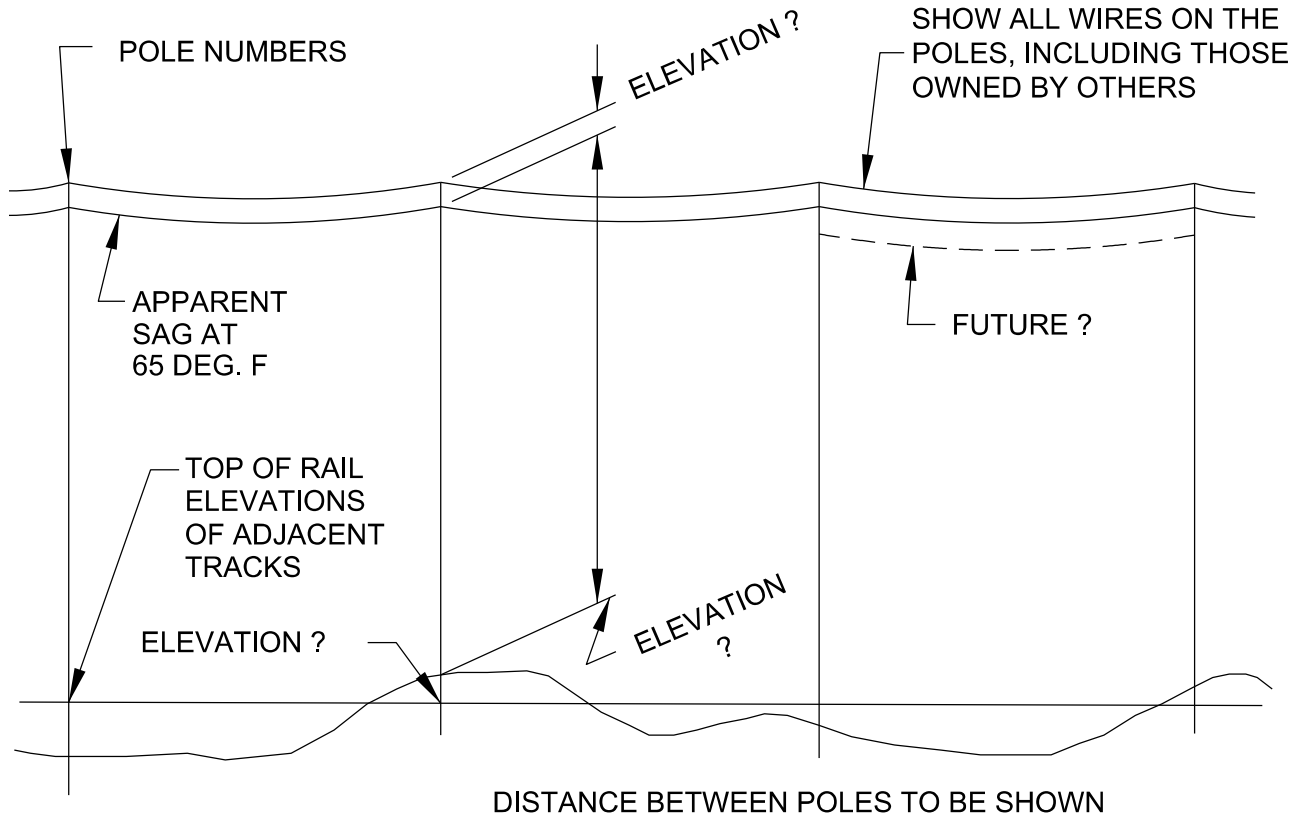

POLE TOP CONFIGURATION TO BE SHOWN SIMILAR TO SAMPLES ABOVE

NOTE: IF POWER LINE CROSSES ANY TRACK, THEN INFORMATION SHOWN ON PLATE 2 IS ALSO REQUIRED.



**PLATE V**

**FOR INFORMATION ONLY  
MINIMUM REQUIREMENTS FOR UNDERCLEARANCE  
OF WIRES OF VARIOUS VOLTAGES**

<u>NOMINAL L-L VOLTAGE</u>	<u>OVERHEAD CLEARANCE</u>	<u>MINIMUM BETWEEN WIRES</u>
0-750	30' - 0"	4' - 0"
To - 15,000	31' - 0"	6' - 0"
To - 50,000	33' - 0"	6' - 0"

Communications cables and fiber optic cables are included in the 0 -750 voltage category.

Calculation for overhead clearance is 33'-0" plus 0.5" per 1,000 volts over 50,000 volts.

Where the distance from the nearer crossing support to the point where the line crosses over the farthest rail is more than 75 feet, the overhead clearance shall be increased by 0.2<sup>th</sup> foot for each 10 feet of the excess over 75 feet. In no case need the distance from the nearest crossing support to the point where the line crosses over the farthest rail be considered in excess of one-half the total length of the crossing span.

For the protection of the wire crossing and railroad pile driver operation, it is preferable that the wire crossing should be located 1,000 feet or more from any railroad bridge, trestle, or large culvert. Where necessary to locate the crossing less than 1,000 feet from such bridge, trestle, or large culvert, the overhead clearance shall be not less than 50 feet above top of rail.

Calculation for minimum between wires is 6'-0" plus 0.5" per 1,000 volts over 50,000 volts.

Where the upper conductor or wire has fixed supports, and the sum of the distances from the point of intersection of the two crossing wires to the nearer supporting structure of each span exceeds 100 feet, the minimum clearance between wires shall be increased by 0.1<sup>th</sup> foot for each 10 feet in excess of 100 feet.

Conductors supported by suspension-type insulators at crossings over communication wires shall be increased by such an amount that the values specified above will be maintained in case of a broken conductor in either adjacent span, provided such conductor is supported as follows:

1. At on support by suspension-type insulators in a suspended position and at the other support by insulators not free to swing (including semi-strain-type insulator).
2. At one support by a strain insulator, and at the other support by a semi-strain-type insulator.

Where necessary for unobstructed view of signals, signs, etc., NCRR may require greater clearances than those specified herein.

The side clearance of poles, towers, and anchor guys shall be not less than 28 feet to the nearest rail.

**PLATE V (continued)**

DEFINITIONS:

NOMINAL L-L VOLTAGE - Means Line - To - Line Voltage

OVERHEAD CLEARANCE - The measured distance (in feet) from the top of the high rail to the bottom of sag of the bottom wire at 60°F.

MINIMUM BETWEEN WIRES - The minimum clearance between the top wire of a NCRR pole line and the proposed bottom power wire.

NOTE 1: The minimum clearance between the top wire of any NCRR pole line and any proposed overhead guy wire shall not be less than 4'-0".

NOTE 2: The minimum clearance from crossing gate tips, C&S cantilever structures, signal masts, signal and other bridges etc. shall conform to the National Electrical Safety Code, section 23, rule 234, but in no case shall the overhead clearance shown in the above table be reduced.

# PLATE VI EXAMPLE PLAN VIEW FOR AERIAL WIRELINE

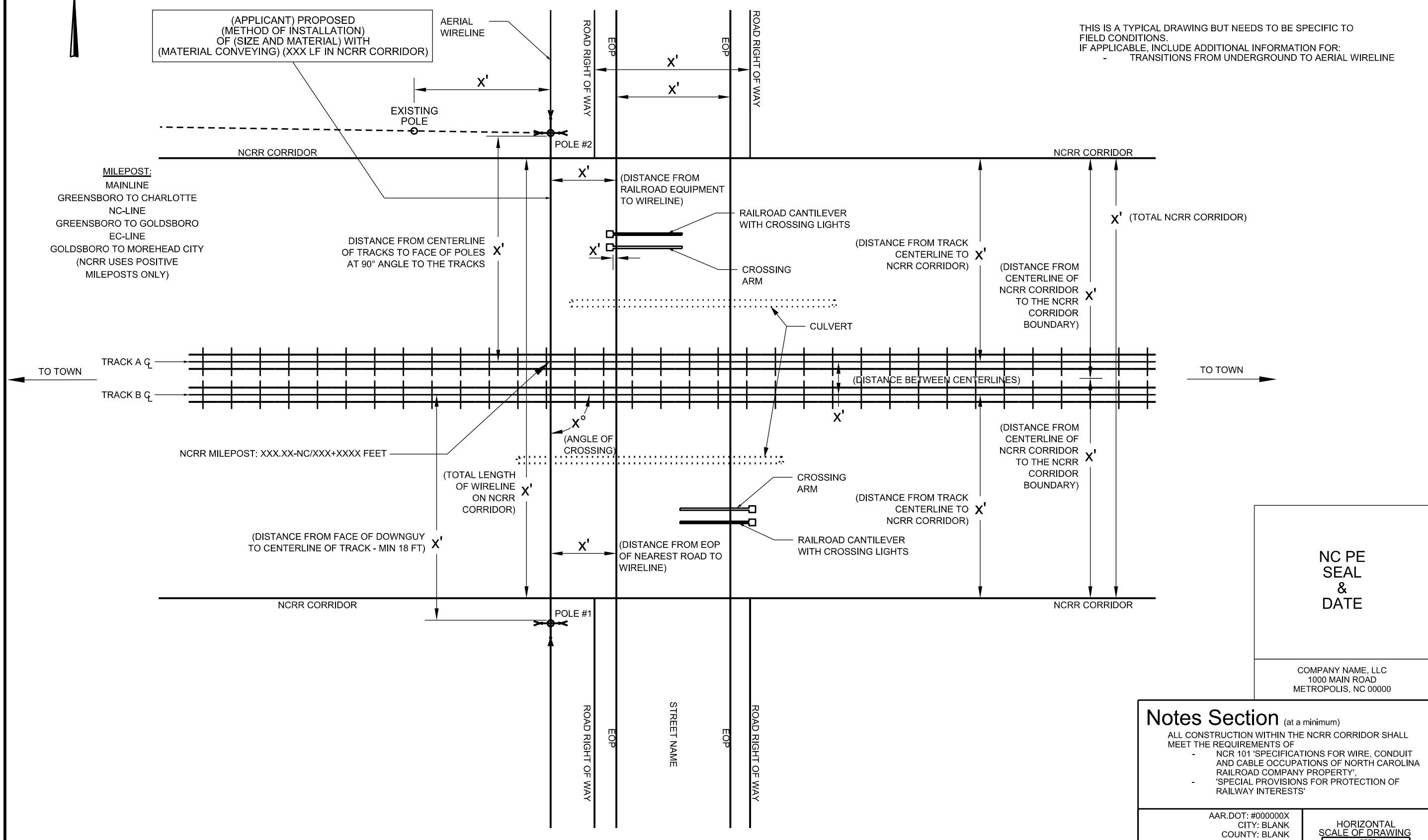

MILEPOST:  
MAINLINE  
GREENSBORO TO CHARLOTTE  
NC-LINE  
GREENSBORO TO GOLDSBORO  
EC-LINE  
GOLDSBORO TO MOREHEAD CITY  
(NCRR USES POSITIVE  
MILEPOSTS ONLY)

THIS IS A TYPICAL DRAWING BUT NEEDS TO BE SPECIFIC TO FIELD CONDITIONS.  
IF APPLICABLE, INCLUDE ADDITIONAL INFORMATION FOR:  
- TRANSITIONS FROM UNDERGROUND TO AERIAL WIRELINE

**NC PE  
SEAL  
&  
DATE**

COMPANY NAME, LLC  
1000 MAIN ROAD  
METROPOLIS, NC 00000

**Notes Section** (at a minimum)  
ALL CONSTRUCTION WITHIN THE NCRR CORRIDOR SHALL MEET THE REQUIREMENTS OF  
- NCR 101 'SPECIFICATIONS FOR WIRE, CONDUIT AND CABLE OCCUPATIONS OF NORTH CAROLINA RAILROAD COMPANY PROPERTY',  
- 'SPECIAL PROVISIONS FOR PROTECTION OF RAILWAY INTERESTS'

AAR.DOT: #000000X  
CITY: BLANK  
COUNTY: BLANK  
STATE: NC  
SHEET NO.: 1 OF 2  
DRAWING DATE: XX/XX/XXXX

HORIZONTAL  
SCALE OF DRAWING  
FEET  
0 X X

# PLATE VII EXAMPLE PROFILE VIEW FOR AERIAL WIRELINE

ALL DIMENSIONS ARE PERPENDICULAR  
TO TRACK CENTERLINES

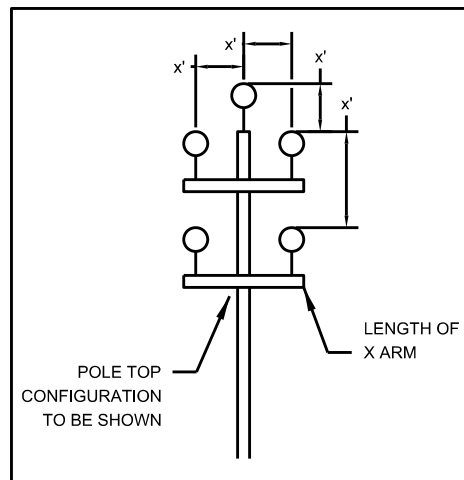
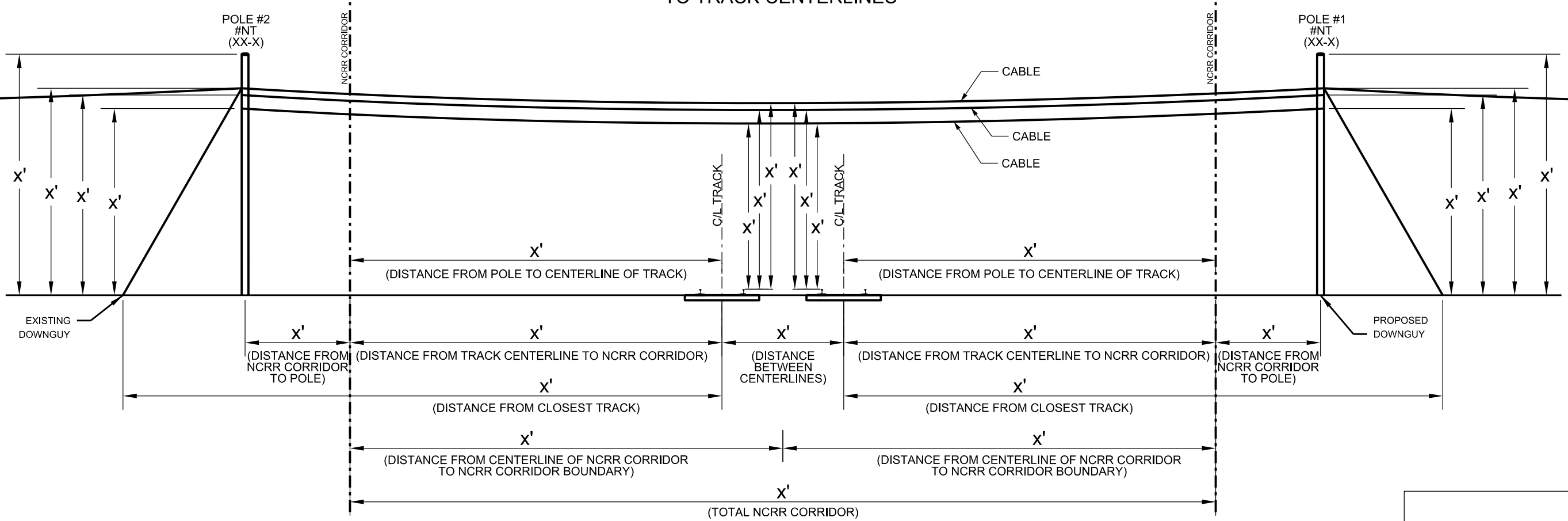

NC PE  
SEAL  
&  
DATE

COMPANY NAME, LLC  
1000 MAIN ROAD  
METROPOLIS, NC 00000

**Notes Section** (at a minimum)  
ALL CONSTRUCTION WITHIN THE NCRR CORRIDOR SHALL MEET THE REQUIREMENTS OF

- NCR 101 'SPECIFICATIONS FOR WIRE, CONDUIT AND CABLE OCCUPATIONS OF NORTH CAROLINA RAILROAD COMPANY PROPERTY',
- 'SPECIAL PROVISIONS FOR PROTECTION OF RAILWAY INTERESTS'

AAR.DOT: #000000X  
CITY: BLANK  
COUNTY: BLANK  
STATE: NC  
SHEET NO.: 2 OF 2  
DRAWING DATE: XX/XX/XXXX

HORIZONTAL  
SCALE OF DRAWING  
FEET  
0 X X

# PLATE VIII EXAMPLE PLAN VIEW FOR UNDERGROUND WIRELINE

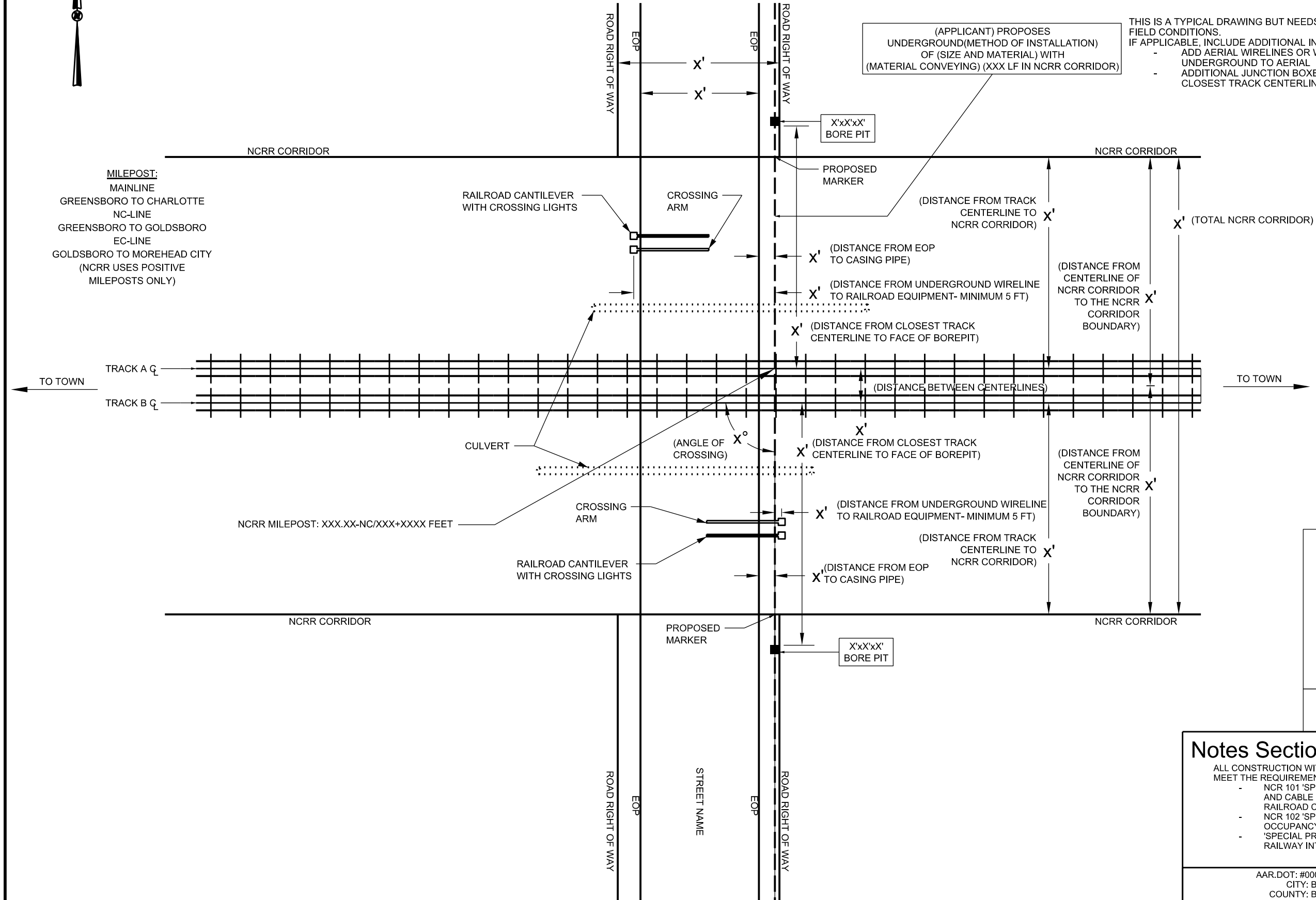

**MILEPOST:**  
 MAINLINE  
 GREENSBORO TO CHARLOTTE  
 NC-LINE  
 GREENSBORO TO GOLDSBORO  
 EC-LINE  
 GOLDSBORO TO MOREHEAD CITY  
 (NCRR USES POSITIVE  
 MILEPOSTS ONLY)

NCRR MILEPOST: XXX.XX-NC/XXX+XXXX FEET

(APPLICANT) PROPOSES  
 UNDERGROUND (METHOD OF INSTALLATION)  
 OF (SIZE AND MATERIAL) WITH  
 (MATERIAL CONVEYING) (XXX LF IN NCRR CORRIDOR)

THIS IS A TYPICAL DRAWING BUT NEEDS TO BE SPECIFIC TO  
 FIELD CONDITIONS.  
 IF APPLICABLE, INCLUDE ADDITIONAL INFORMATION FOR:  
 - ADD AERIAL WIRELINES OR WHERE TRANSITIONS FROM  
 UNDERGROUND TO AERIAL  
 - ADDITIONAL JUNCTION BOXES OR BORE PITS (DISTANCE FROM  
 CLOSEST TRACK CENTERLINE TO FACE OF BOREPIT)

**NC PE  
 SEAL  
 &  
 DATE**

COMPANY NAME, LLC  
 1000 MAIN ROAD  
 METROPOLIS, NC 00000

**Notes Section** (at a minimum)

ALL CONSTRUCTION WITHIN THE NCRR CORRIDOR SHALL  
 MEET THE REQUIREMENTS OF

- NCR 101 'SPECIFICATIONS FOR WIRE, CONDUIT  
 AND CABLE OCCUPATIONS OF NORTH CAROLINA  
 RAILROAD COMPANY PROPERTY',
- NCR 102 'SPECIFICATIONS FOR PIPELINE  
 OCCUPANCY', AND
- 'SPECIAL PROVISIONS FOR PROTECTION OF  
 RAILWAY INTERESTS'

AAR.DOT: #000000X  
 CITY: BLANK  
 COUNTY: BLANK  
 STATE: NC  
 SHEET NO.: 1 OF 2  
 DRAWING DATE: XX/XX/XXXX

**HORIZONTAL  
 SCALE OF DRAWING**

0      X      X  
FEET

# PLATE IX EXAMPLE PROFILE VIEW FOR UNDERGROUND WIRELINE

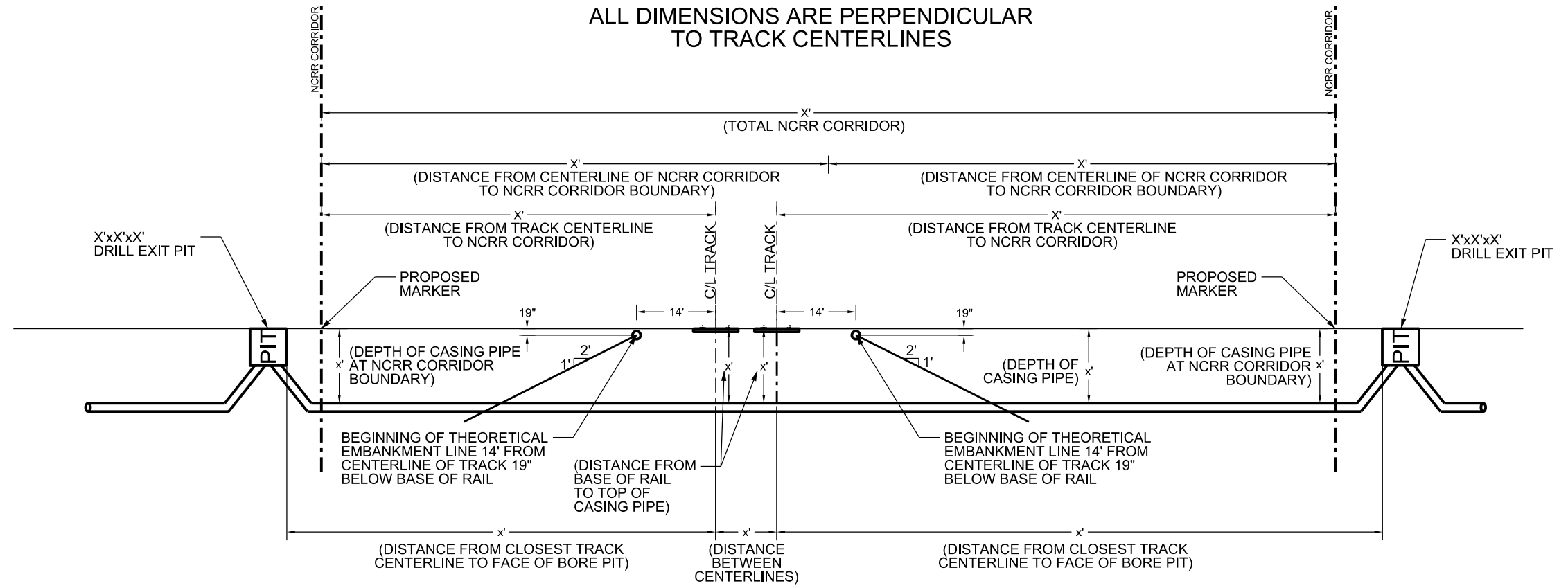

NOTE: O.D. = I.D. + ( 2 x (WALL THICKNESS) )

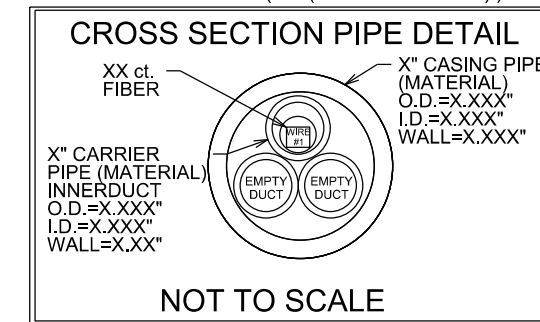

### MARKER DETAIL

## WIRELINE

TOWN OF METROPOLIS  
123 MAIN ST.  
METROPOLIS, NC 00000  
16" WATER MAIN (100 PSI)  
3' - 0" BELOW GRADE

FOR INFORMATION OR IN  
CASE OF RUPTURE CALL:  
WEEKDAY: (555) 555-1234  
EVENING: (555) 555-1234  
WEEKEND: (555) 555-1234

**SIGN DATA:**

- 1/8" ALUMINUM PANEL
- 3M SCOTCH LIFE "ENGINEER GRADE"
- SHEETING OR APPROVED EQUAL.
- RED COPY ON WHITE BACKGROUND
- MOUNT SIGN PANEL 5' ABOVE GRADE (MIN.)
- USE 2 LB/FT U-CHANNEL POST (MIN.)
- MOUNT SIGNS BACK-TO-BACK ON POST.

### NC PE SEAL & DATE

COMPANY NAME, LLC  
1000 MAIN ROAD  
METROPOLIS, NC 00000

### Notes Section (at a minimum)

ALL CONSTRUCTION WITHIN THE NCRR CORRIDOR SHALL MEET THE REQUIREMENTS OF

- NCR 101 'SPECIFICATIONS FOR WIRE, CONDUIT AND CABLE OCCUPATIONS OF NORTH CAROLINA RAILROAD COMPANY PROPERTY',
- NCR 102 'SPECIFICATIONS FOR PIPELINE OCCUPANCY', AND
- 'SPECIAL PROVISIONS FOR PROTECTION OF RAILWAY INTERESTS'

AAR.DOT: #000000X  
CITY: BLANK  
COUNTY: BLANK  
STATE: NC  
SHEET NO.: 2 OF 2  
DRAWING DATE: XX/XX/XXXX

HORIZONTAL  
SCALE OF DRAWING

FEET

0      X      X